



G740A

residential heavy gate opener for **sliding gates**

Instructions for installation & use



Toll free helpline

Please have your serial number and model name available before calling.

Australia 1800 638 234

New Zealand 0800 653 667

United Kingdom 0800 073 0112

www.merlingo.com

Important safety instructions for installation



WARNING Incorrect installation can lead to severe injury. Follow all installation instructions. Merlin Garage Openers Limited does not accept responsibility for damage or injury resulting from installing this opener.

Prepare the gate for safe automation

Before installing the drive remove or disable any equipment, such as locks, that is not needed for powered operation.

Check that the gate is in good mechanical condition and that it opens and closes properly. Do not use force sensitivity adjustments to compensate for a binding or sticking gate. Excessive force may damage the gate.

Avoid possible entrapment points

Ensure that entrapment between the driven part and the surrounding fixed parts due to the movement of the driven part is avoided.

Gaps are considered safe as follows (IEC60335-2-103): finger gaps above 25 mm; foot gaps above 50 mm; head gaps above 300 mm; and whole body gaps above 500 mm.

Add over-ride switch if wicket gate is present

If a wicket gate is present in a gate leaf, it must be fitted with a switch that prevents the drive from operating when the wicket is open. (Connect a Normally Closed switch to the STP and GND terminals of the controller board.)

Locate controls carefully

Install any fixed control, wired or wireless, within sight of the gate but away from moving parts and at a height of more than 1.5 m.

Fit non-contact safety beams

Where they are not already explicitly required to comply with regulations, Merlin strongly recommends fitting non-contact safety beam sensors.

Locate the entrapment warning sign correctly

After installing the drive, the included entrapment warning sign must be fitted within sight of anyone that may stand in the path of the moving gate.

Inspect and test the installation

After installation, ensure that the mechanism is properly adjusted and that the protection system and manual release function correctly.

Educate the owner

Before handing controls to the user, alert them to the potential dangers, and routine checks they're required to perform.

Complete the commissioning check sheet

The commissioning check sheet at the end of this manual must be completed, signed by the installer and client, and kept on record by the installing company. It contains a declaration that all safety related procedures have been complied with.

Important safety instructions for use



WARNING It is important for the safety of persons to follow all the instructions for use. Save these instructions.

Controls are not a toy

Do not allow children to play with fixed or remote controls.

Check the gate and drive for wear

Frequently examine the installation for imbalance and signs of wear or damage.

Check that the manual release functions correctly.

Do not use if repair or adjustment is necessary.

Test the safety system every month

Every month, test that the gates stop or reverse in response to an obstruction, and that interrupting the beam of and photo-electric safety beam also causes the gate to stop or reverse..

Do not use if repair or adjustment is necessary.

Disconnect power before maintenance

Always disconnect the power supply from the drive before cleaning or maintaining the gate or drive. The drive or gate may operate unexpectedly due to other users with remote controls, or due to automatic closing (if enabled).

Become familiar with the controls and manual release before use

Before using the gate and drive, locate the manual release and become familiar with its operation. Note where the key is located, in the case of a power cut or any failure of the drive or gate.

Contents

Manually opening the gate	4	Easy setup	17
Maintenance	4	Controls	18
Learning wireless controls	5	Professional setup	21
Deleting all wireless controls	5	Testing the gate operation	22
Deleting selected wireless controls	5	Warranty	23
Site requirements	6	Troubleshooting	24
Board setup	9	Specifications	25
Connections	9	Service Centres	26
Learn a remote control	12	Quick setup guide	27
Set the limits of travel	12	Commissioning check sheet	28
Template for G740A foundation plate	14		

Manually opening the gate

Insert the key provided into the lever on the side of the base of the drive. Turn the key and pull the lever outwards until it stops.



Maintenance

In an area where ant or insect infestation is likely, regularly spray around the opener and any electrical installation with insecticide. In normal conditions it is not expected that any additional lubrication or service is required. Keep the path of the gate free from debris and foliage.

The gate and its moving parts may sustain damage or wear, presenting additional load to the opener. Frequently examine the installation for signs of wear or damage. Do not use if repair or adjustment is needed as the gate may cause injury.

Each month check the sensitivity of your gate while it is closing and opening. Arrange for an Authorised Installer to adjust if necessary since an incorrect adjustment may be hazardous.

Each month check that any non-contact beam sensors function correctly by obstructing them while the gate is moving. The gate should stop, or reverse. Ensure the beams are clear of any obstructions or dirt and ensure they are aligned towards each other.

Learning wireless controls

1. Press P2/RADIO until the red LED is lit.
2. If the wireless remote controls are required to only operate Pedestrian Access mode, install the CH-RADIO jumper over its pins. If the wireless remote controls are for full access, remove the CH-RADIO jumper.
3. Press the desired button for 3 seconds once on each wireless control that is required to operate the gate.
NOTE The red LED will blink during learning. The controller is ready for another wireless control when the red LED is steadily lit.
4. Press P2/RADIO to exit learning mode.
NOTE The learning procedure will time out after 10 seconds of no activity.

Deleting all wireless controls

1. Press and hold the P2/RADIO button until the red LED blinks rapidly.
2. Release the P2/RADIO button.
3. Within 6 seconds, press the P2/RADIO button again to confirm.
Deletion is indicated by the red LED blinking faster.

Deleting selected wireless controls

The optional accessory GT/SYSTEM hand-held controller is required. Contact Merlin for details.

Site requirements

Check that the temperature range marked on the drive is suitable for the location. Do not install the drive where ambient temperatures will exceed the ratings.

Gate

This opener is designed for residential sliding gates of any length, but weighing less than 800 kg.

Using a spring balance, check that less than 15 kg force (150 N) is required to manually move the gate through its full range of movement, with the gate disconnected from the drive.

The gate should operate smoothly, opening and closing without sticking. Check the mounting points for strength and stiffness. Reinforce if necessary.

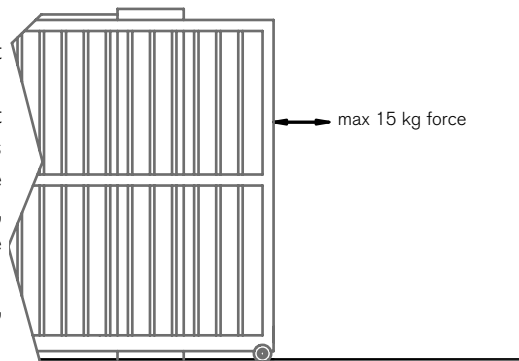

Gate posts

There should not be any visible flexing of the mounting points under load.

Level and square the gate

For best performance the gate track should be perfectly level along its full length. However, for some gate weights, it will be possible to pull the gate up a slight angle. Refer to the brochures for details, but for a 6 degree slope, the heaviest allowable gate is 300 kg; for a 3 degree slope, the heaviest allowable gate is 500 kg. The gate and its tracks and rollers should not be damaged or bent.

Power supply

The 3-pin mains power plug should be shielded from the effects of weather.

The product is tested as a unit for electrical safety compliance and if the plug is cut off for hard-wiring, then the electrical safety of the unit becomes the responsibility of the installing electrician.

An isolating switch is recommended, but all mains wiring should be in accordance with local regulations.

Wiring

All wiring must be arranged to prevent water entering the controller enclosure. Do not wire mains voltages and low voltage control wires in the same conduit.

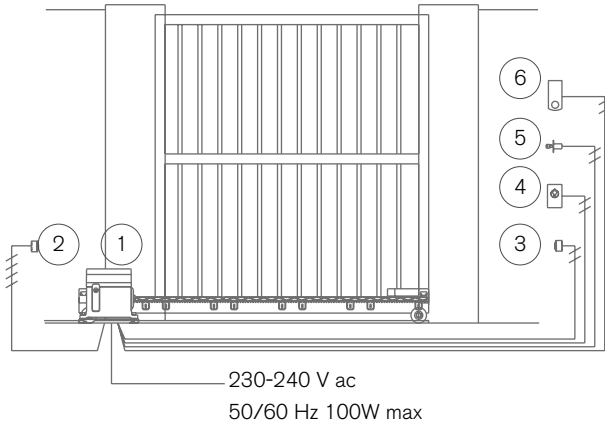

- 1 Opener
- 2 Receiving IR sensor (4-wire)
- 3 Transmitting IR sensor (2-wire)
- 4 Push-button (must be rated suitably for the weather conditions)
- 5 Keyed switch (must be rated suitably for the weather conditions)
- 6 Keypad (Merlin M840, wireless, optionally with wired power supply)

NOTE The Merlin M122 wired and M128 wireless pushbuttons are not waterproof, and are only rated for interior use. The Merlin KWF1 keyed switch is not intended for use fully exposed to weather in gate installations. Merlin does not warranty any items used outside their published ratings or intended use.

Installation

Locating the foundation plate relative to the gate

Position the foundation plate correct distance from the face of the gate

Position the foundation plate as shown. Secure it using concrete and anchor bolts. Ensure the cable conduit aligns with one of the apertures in the plate.

The surface of the foundation plate must be level and its edge must be exactly parallel to the gate. The edge of the plate should be 50 mm from the face of the gate.

Position the foundation plate correct distance from the ends of the gate

The foundation plate must be positioned to allow the gate to move fully past the opening. If the supplied limit actuating plates are attached to the rack with no modification then the gate must extend past the foundation plate as per the measurements shown.

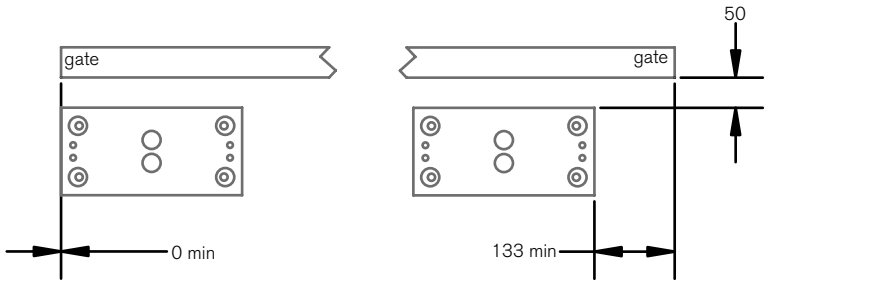

Position the drive on the foundation plate

Remove the cover from the drive and place it on the foundation plate.

Centre the mounting bolts in the drive's mounting slots.

Fit 2-mm thick spacer shims under the drive – these will be removed afterwards.

Tighten the four bolts ensuring that the drive is parallel to the gate

Operate the manual release clutch, using the key provided, pulling the lever fully out.

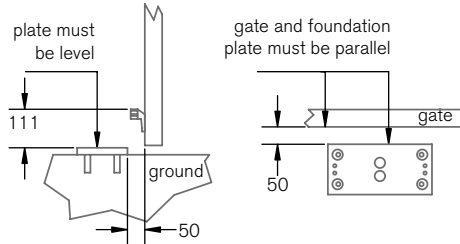

Fix the rack to the gate

With the clutch released, slide the rack over the pinion gear. Attach one end of the rack to the gate, then slide the gate along, attaching each point of the rack as it passes the pinion.

Ensure sufficient rack protrudes past the sprocket so that the limit actuators are able to be attached.

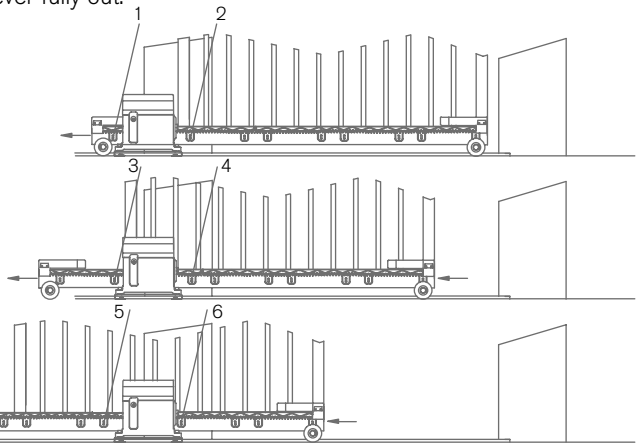

Remove the shims

Loosen the bolts holding the drive on the foundation plate; remove the 2-mm shims.

Retighten the four mounting bolts. This provides the correct engagement of the rack and pinion teeth.

Fit and adjust the limit actuator plates

Allow the gate to slide manually to each end position and fit the limit actuator plates to the rack, such that the limit switch is activated. This can be fine tuned after the power is connected to the drive.

Board setup

It is strongly recommended to follow the procedures in the order below:

1. Make all Connections
2. Learn a remote control
4. Set the limits of travel
5. Run Easy Setup
6. Adjust Controls
7. Run Professional or Easy Setup again
8. Learn wireless remote controls

Connections

NOTE When powering any accessories from the board, (for example: gate latches, additional receivers, keypads, PE beams) ensure the total combined load on the VA and TXF terminals does not exceed 150 mA. If necessary, remove accessories or provide additional power supplies directly to each accessory.

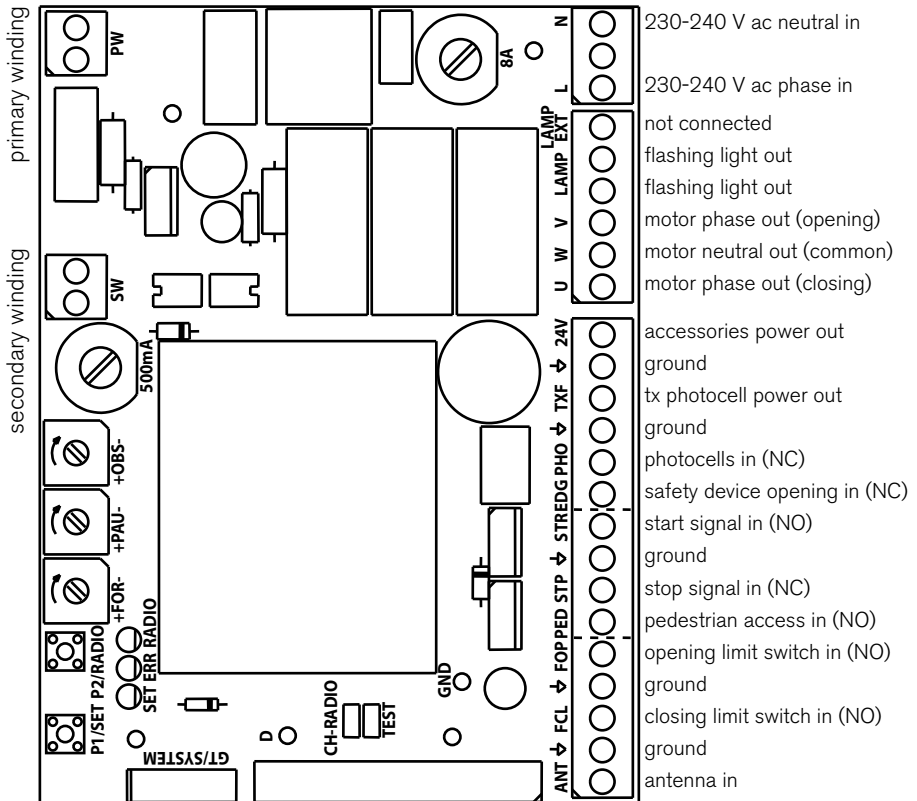

230-240 V ac mains input (L, N)

Connect the neutral wire to N; connect the live wire to L. An earth terminal is not provided.

flashing warning lamp output (LAMP)

The outputs are set up for a 24 V dc, 2 W flashing warning light. The board supplies power to the lamp, but it is a continuous supply, so the lamp must have a flashing circuit built in. The output supplies power to the lamp from 1 second prior to opening, until fully open; and from two seconds prior to closing, until fully closed.

motor outputs (U, V, W)

W is the neutral wire connection, and should connect to the central tapping wire of the ac motor.

U & V are switched phase connections, and should connect either side of the motor capacitor, and on to each motor winding wire. Ensure that U and V are connected to give the correct closing and opening directions on the gate installation. Reverse these connections if the motor travels in the wrong direction.

tx photocell power output (TXF), photocell signal input (PHO)

Photocells should have NC (normally closed) contacts when there is no obstruction. Fit a jumper wire between the signal input terminal and ground if no photocells are fitted.

The maximum total accessory power load allowed is 24 V 150 mA. The combined consumption on the TXF and 24V terminals must not exceed this limit. Photocells are part of this total load.

NOTE 1 If the TEST jumper is fitted, the unit performs a function test on the photocells before each operation. This adds a 200ms delay before every operation. The transmitting photocell must be powered from the TXF output. Photocells must have NO (normally open) contacts when the power is off.

NOTE 2 If the PAU trimmer is set to fully anticlockwise and the photocell beam has been interrupted, then the gate will close 1 second after the beam is cleared.

NOTE 3 The default behaviour of the gate is to react immediately when the beam is interrupted. Professional setup Step 12 allows this to be changed. The gate can be made to stop in response to an obstruction, and then only react after the obstruction is removed.

accessory power output (24V)

The maximum total accessory power load allowed is 24 V 150 mA.

Accessories in excess of this limit must be powered directly from an auxiliary power supply.

NOTE Transmitting photocell must be powered from the TXF output if the TEST jumper is fitted.

start signal input (STR)

This input is NO (Normally Open). When it is momentarily closed to ground the opener will start. If the gate is already moving then momentarily closing the start input to ground will stop the movement.

Connect a keyed switch or exit request button to this input.

While this input is closed to ground, any auto-closing function is disabled.

This input can be connected to a timer to force the gates open during certain periods of time.

stop signal input (STP)

The Stop input is NC (Normally Closed). Fit a jumper if no switch is used. When this terminal is not connected to ground, the gate will not operate – it will not open or close until the terminal is reconnected to ground, and it will only restart once a command is sent through the Start input, or through a learned wireless remote control. If the gate is moving when this terminal is momentarily disconnected from ground then the gate will stop moving until the connection is re-established, and then only when another Start command is received.

pedestrian access signal input (PED)

This NO (Normally Open) input can connect to safety devices such as pressure edges, or to a switch that enables the gate to open.

Activating a safety device will prevent movement from fully open or fully closed, and will cause movement to reverse while opening. Safety devices connected to PED have no effect during closing.

A switch connected to the PED terminal will cause the gate to open. The factory default setting opens the gate for 5 seconds, and this can be over-ridden using the professional setup routine. The gate will close automatically if auto-close is enabled; otherwise another manual command is required. Normal opening and closing commands take priority over Pedestrian Access commands.

It is also possible to activate Pedestrian Access using a wireless remote control that has been learned while the CH-RADIO jumper is fitted.

antenna input (ANT)

The centre wire of a 50-ohm co-axial cable should connect to this terminal. An antenna of 175mm is recommended.

Connect the outer braid of the co-axial cable to the ground terminal.

A ground plane greatly improves an antenna's performance. It should connect to the end of the co-axial cable's braided screen. An alternative is to mount the antenna through a metal plate that is at least as large as the ground plane's length.

Learn a remote control

A remote control is useful for operating the controller during setup.

Press and hold P2/RADIO until the red LED is lit. Press the main button on the remote control. Wait 10 seconds to exit learning mode.

Install the CH-RADIO jumper. Press and hold P2/RADIO until the red LED is lit. Press the second button on the remote control. Wait 10 seconds to exit learning mode. Remove the CH-RADIO jumper.

Now the main remote button will act as P1, and the second button act as P2.

Set the limits of travel

Limit switches must be set before any further setup of the controller board.

Attach the limit switch actuating plates to the rack as required, such that when the gate is in the fully open and fully closed positions, the limit switch on the drive is triggered.

Template for G740A foundation plate

NOTE The positions of the holes, and the plate itself, are symmetrical. The total length of the plate is 300 mm, so it extends 5 mm past the left hand edge of this page.

NOTE Ensure cables and conduit are pulled through the cable entry holes when the plate is bolted to the ground.

↑
pinion
centre-line

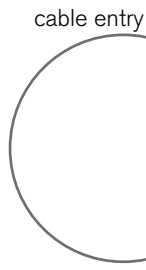
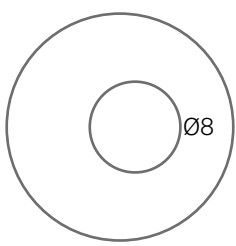
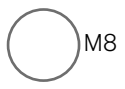
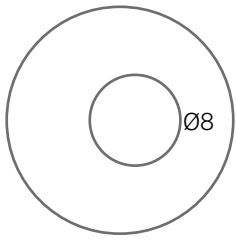

NOTE template limited by paper size. Allow 5 mm more past this edge.

hole



hole



pinion centre-line
↓

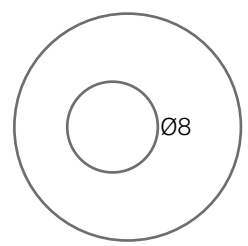
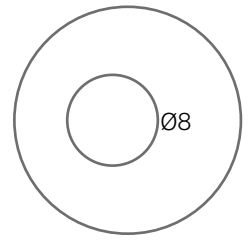

Easy setup

Easy setup must be performed to set the opening and closing travel times.

NOTE Easy setup only sets the limits and force/speed, and is fully automated; professional setup also offers slow-stopping and pedestrian access, but is not fully automated. It is an automated procedure that sets the gate leaf travel times based on the detection of the limits of travel.

CAUTION During this procedure the gates must be attended. Movement can be stopped at any point by pressing the P1/SET button. The gate must be in the midway position before starting this procedure.

To initiate the procedure, press P1/SET then, while the yellow LED is flashing, press P1/SET again for 1 second.

The following steps are performed automatically:

1. Checks for presence of a motor; photocells (or a jumper) on PHO terminal; e-stop (or a jumper) on STP terminal.
2. Sets pedestrian opening to half way.
3. Begins to open the gate, with a force set by the FOR trimmer.
NOTE If the gate begins to close first, switch off the power to stop the movement and then reverse the motor wiring accordingly. Start this setup procedure again.
4. After 3 seconds of opening, gates stop moving.
5. Closes the gate fully, stopping using the closed limit switch.
6. Opens the gate fully, stopping using the open limit switch.
7. Pauses 3 seconds at fully open.
8. Closes fully, slowing down to around 1/3 speed, after 90% of the travel time.

In summary the procedure is: open 3 seconds, close fully, open fully, wait 3 seconds, close fully.

Controls

IMPORTANT If the force/speed/voltage setting (FOR) is adjusted then it is necessary to perform either Easy Setup or Professional Setup again because the travel times will vary. Failure to do this risks causing damage to the gates or gate stops.

After every trimmer adjustment press P1/SET to confirm the change. Wait for the LED to stop flashing.

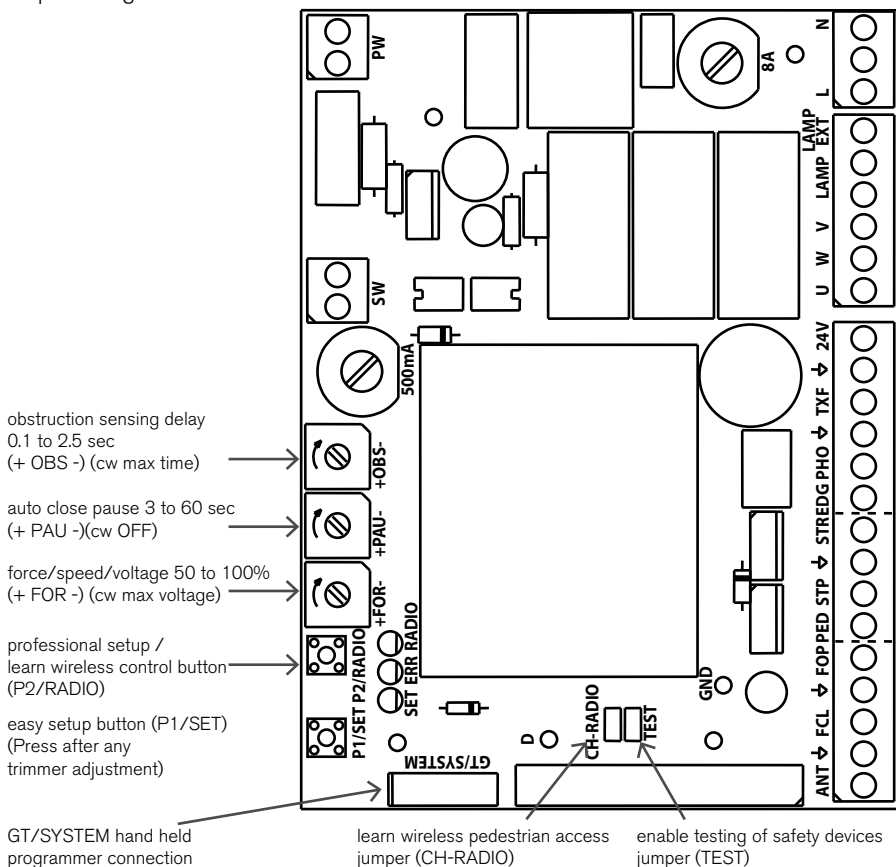

easy setup / reset button (P1/SET)

Press to reset the board. The board is reset when the yellow LED stops flashing. Press within 5 seconds of applying power to the board, or while the yellow LED is flashing, to enter the Easy Setup routine.

Also used in conjunction with P2/RADIO to set the Application Mode, that is how much maximum motor current is allowed.

learn wireless control button (P2/RADIO)

Press and hold P2/RADIO, until the red LED is lit, to begin learning wireless remote controls. The red LED will be lit. Press a button for 3 seconds on each wireless control to be learned. Either wait 10 seconds, or press P2/RADIO again to exit learning. If the CH-RADIO jumper is fitted, the wireless controls will operate the pedestrian Access mode; if it is removed then they will operate the gate normally.

To enter the Professional Setup routine press P2/RADIO within 5 seconds of pressing RESET, or applying power to the board, or while the yellow LED is flashing.

learn wireless pedestrian access jumper (CH-RADIO)

Place this jumper over the pins when you want to learn wireless remotes for Pedestrian Access mode.

force/speed/voltage setting trimmer (+ FOR -)

NOTE Press P1/SET after adjusting the trimmer.

The energy transferred to an obstruction is determined by the motor power, and the time that the power is applied to the obstruction. Motor power is determined by the maximum voltage and maximum current. This FOR setting alters the motor voltage. The Application Mode (page 7) alters the maximum allowable motor current. The OBS setting alters the time that power is applied to an obstruction. So safety is determined by a combination of the settings for FOR, OBS, and Application Mode.

Turn FOR clockwise to increase the voltage that is applied to the motors.

- Full clockwise: maximum voltage (less sensitive)
- Full anti-clockwise: min. voltage, approx. 50% of the maximum (more sensitive)

NOTE Voltage affects the speed of the motor. After any adjustment to FOR, either the Easy Setup or the Professional Setup procedure must be completed to set the operating time correctly.

auto-close pause setting trimmer (+ PAU -)

NOTE Press P1/SET after adjusting the trimmer.

WARNING Photocell sensor beams must be fitted when using auto-close.

This trimmer determines the length of time that the gate pauses before auto-closing.

- Full clockwise: auto-closing is disabled (that is, there is an unlimited pause when open)
- Full anti-clockwise: pause open for 15 seconds, then auto-close (unless a photocell is fitted)
- Other positions: adjust for pause times of between 3 seconds and 60 seconds

NOTE In auto-closing mode, any command to open or close will cause the following behaviour:

- while opening, commands are ignored;
- while closing, commands will cause the gate to start to open;
- while paused open, commands will not close or open, but will restart the pause timer

NOTE If a photocell is connected to the PHO terminal then the response to interruptions of the beam will vary depending on the setting of the PAU control, and depending on the choice of option in professional setup:

- PAU full anti-clockwise:
Gate opening - nothing happens if the beam is interrupted
Gate paused open for 15 seconds - if beam is interrupted nothing happens until the interruption is removed; 1 sec after interruption is removed the gate will close
Gate closing - if the beam is interrupted, then open fully, pause for 1 second, and begin to close
- PAU in all other positions:
Gate opening – nothing happens if the beam is interrupted
Gate closing - if the beam is interrupted, then open fully

Photocell option setting - see Professional Setup.

If the 'stop when interrupted, move when clear' option is enabled in Step 12 of Professional Setup, the above behaviours will be modified accordingly:

- PAU full anti-clockwise:
Gate opening - stop if the beam is interrupted, continue opening when the beam is clear, once open the gate will autoclose after 1 second (not 15 seconds as usual)
Gate paused open for 15 sec - if beam is interrupted nothing happens until the interruption is removed; 1 sec after the interruption is removed the gate will close
Gate closing – stop if the beam is interrupted, then open fully when the beam is clear, pause for 1 second, and begin to close
- PAU in all other positions:
Gate opening – stop if beam interrupted, continue opening when beam is clear
Gate closing – stop if the beam is interrupted, then open fully when the beam is clear

obstruction sensing trimmer (+ OBS -)

NOTE Press P1/SET after adjusting the trimmer.

Turn this clockwise to make the gate less sensitive, that is to increase the time delay that occurs before reacting to the detection of an obstacle. Turn anti-clockwise to make the gate more sensitive to obstructions.

- Full clockwise: maximum time delay of 2.5 seconds before reversing (less sensitive)
- Full anti-clockwise: minimum time delay of 0.1 seconds before reversing (more sensitive)
- Other positions: adjust for delay times of between 0.1 and 2.5 seconds

enable testing of safety devices jumper (TEST)

Connecting the TEST jumper across its two pins will cause the controller to verify the operation of the photocell and / or safety edge before every operation. This test switches off the power to the safety device and verifies that the device's output changes state. Therefore the safety device must be capable of being tested in this way.

A 200 ms delay is created before every movement.

The TEST jumper must be removed if safety devices are not fitted.

Professional setup

Professional setup is a semi-automated procedure, similar to Easy Setup, but with the following differences:

- Initiate by pressing P2/RADIO instead of P1/SET
- The installer must intervene to manually operate the gate
- The installer may set a desired slow-down position, if not there will be no slow-down
- The installer must intervene to manually close the gate
- The installer may change the behaviour in response to photocells
- If pedestrian opening is required, then the installer must set it, otherwise pedestrian opening time is zero

NOTE This procedure sets the gate travel time based on the detection of the limits of travel. Limit actuating plates must be fitted to the rack.

CAUTION During this procedure the gate must be attended. The gate must be in the midway position before starting this procedure.

To initiate the procedure, press P1/SET, then while the yellow LED is flashing, press P2/RADIO again for 1 second.

NOTE It may be more convenient to use a transmitter to control the process, than to press the P1/SET and P2/RADIO buttons on the controller board. If so, learn one button for P1 (learn the button with the CH-RADIO jumper removed), and one button for P2 (learn the button with the CH-RADIO jumper fitted).

The following steps are performed automatically:

1. Checks for presence of a motor; photocells (or a jumper) on PHO terminal; e-stop (or a jumper) on STP terminal.
2. Begins to open the gate, with a force set by the FOR trimmer.
NOTE If the gate begins to close first, switch off the power to stop the movement and then reverse the motor wiring accordingly. Start this setup procedure again.
3. After 3 seconds of opening, gate stops moving.
4. Closes the gate fully, stopping using the closed limit switch.

The following steps must be performed by the installer:

5. Press either P1/SET or P2/RADIO to begin opening the gate
6. Press P1/SET at the time where M1 slow down to 1/3 speed is required
7. The gate will continue to open fully, stopping using the open limit switch.

The following steps alter the response to interruptions of any photocells. Step 11 makes no change, Step 12 selects the 'stop when interrupted, move when clear' option:

8. Only press P1/SET to close the gates if:
 - a. photocell is obstructed when closing then reverse immediately, and;
 - b. photocell is obstructed when opening do nothing
9. Only press P2/RADIO to close the gates if:
 - a. photocell is obstructed when closing then stop and only reverse when obstruction is removed, and;
 - b. photocell is obstructed when opening then stop and continue opening when

obstruction is removed

10. The gate will close fully, slowing down at the time previously chosen

Only perform step 11 if pedestrian access is required:

11. Press P1/SET or P2/RADIO. The gate will begin opening. Press P1/SET at the time where the gate is at the desired open position for pedestrian access. The gate will close fully and the unit will exit Professional Setup.

12. If Pedestrian Access is not required, press P1/SET and P2/RADIO simultaneously

NOTE The professional setup procedure will time out after four minutes if abandoned.

Testing the gate operation

Test the operation of all controls and safety devices.

Allow for the effect of weather. Wind or water may make the gates more difficult to move.

If the sensitivity is set to react to extremely light obstructions then the gates may fail to open or close fully.

After adjustment, check that the force on an obstruction at the far end of the gate leaf does not exceed 150N (15 kg). Use a spring balance.

Warranty

Limited warranty

Merlin Garage Openers Limited warrants to the original purchaser ("the Buyer") that the controller ("the Unit") sold under this warranty will be free from defects in materials and workmanship for a period of 24 months from date of purchase. Accordingly if the Unit fails due to defects in materials or workmanship within the warranty period Merlin Garage Openers Limited will, provided the defective part or Unit is returned freight and insurance prepaid and well packaged to the nearest address listed in this manual, undertake to repair or, at its option replace, any defective part or Unit and return it to the Buyer at no cost. Repairs and replacement parts are warranted for the remaining portion of the original warranty period.

Limitations

It expressly excludes any batteries and malfunctions or defects to the Unit or its operation due to any of the following:

- A Failure to observe installation, adjustment, maintenance or operating instructions provided with the Unit;
- B Incorrect installation, operation or adjustment of products to which the Unit is fitted;
- C Connection to any load outside the specifications set out in the owner's manual;
- D Any modification or repair to the Unit carried by a person not authorised to do so by Merlin Garage Openers Limited;
- E Radio or any other electrical or electronic interference;
- F Faulty or unsuitable electrical wiring of the building to which the Unit is attached;
- G Faulty or flat batteries in the remote control transmitter;
- H Where the defect is due to: conditions other than normal domestic use or dirt, misuse, neglect, fire, accident, electrical storm or other act of God.

This warranty is void if the labelling has been altered, defaced or moved. The liability of the Distributor for any loss or damage or injury arising directly or indirectly from any defect in the goods supplied is limited to the replacement or repair of such goods or to damages not exceeding the invoice value of such goods at the option of Merlin Garage Openers Limited.

Future Modifications

Merlin Garage Openers Limited may modify any existing or future model of the Unit without the obligation to incorporate these modifications into Units already manufactured or into the Unit to which this warranty applies.

General

This warranty is the only Warranty made by Merlin Garage Openers Limited. All other warranties, representations and conditions of any kind, express or implied, are hereby excluded. This warranty does not deprive the Buyer of any rights conferred upon them by any applicable law or statute in their country of purchase. Proof of date of purchase may be required when making a claim under warranty. In the event that the Buyer is unable to provide adequate proof of purchase the date of warranty will apply from date of shipment from the Distributor to the Reseller.

NOTE Merlin requests that you attach your sales docket or invoice to this manual to enable you to establish the date of purchase in the unlikely event of service being required.

Troubleshooting

Gate will not open or close

The gate should operate smoothly, opening and closing without sticking or requiring undue force. Release the gate from the opener and check that it is possible to move the gate freely by hand through the full range of the opening.

May be a power failure. Plug another appliance into the power point to check. Opener may require service. If solar powered, the battery may not be fully recharging.

SOLUTION: Operate the gate manually. Phone an installer for service.

Gate will open but not close

If photocells are fitted then they may be obstructed or misaligned. The gate mechanism may have broken, presenting an abnormal load, causing the safety system to activate.

SOLUTION: Look for anything blocking the photocell beam. Is it aligned correctly? Release the manual release and check the gate can be operated easily by hand. Have your gate repaired or serviced if it is heavy to move by hand.

Transmitter range is less than normal

Your transmitter battery may be going flat. If you have an external antenna then the wire may be damaged.

SOLUTION: Replace the transmitter battery. Phone for service if the antenna wire is damaged

Transmitter doesn't work some times

There may be occasional radio interference in your area. Your transmitter battery may be going flat.

SOLUTION: Check for nearby baby monitors, remote control toys, cordless phones. Replace the transmitter battery.

Radio interference

Gate remote controls are required to operate in shared radio frequency bands. Regulations permit other users to continuously operate higher powered devices such as baby monitors or wireless headphones in these shared bands. These devices may cause radio interference that reduces the performance of the remote control. Switch off interfering devices if possible. Remote controls and receivers that operate on alternative frequencies are available at additional cost.

Transmitter doesn't work at all

Your transmitter battery may be flat.

SOLUTION: Replace the transmitter battery.

Specifications

Model number	G740A
Supply required	230-240V ac, 50Hz
Accessory output	24 V dc, max 150 mA total (fused)
Rated load	max 400 N (approx. 40 kg force)
Rated duty cycle	max 80%
Application	residential heavy duty
Stand-by power consumption	max 0.5 W (with no accessories fitted)
Gate weight	max 800 kg
Operating speed	typ 12 m/min
Replacement board fuse	500 mA (5 x 20)
Replacement motor fuse	8 A (5 x 20)
Remote control battery	Depends on model, either 4LR44 (6V) or CR2025 (3V)
Operating temperature range	-20 to +55 °C
Receiver	Integrated 433 MHz high-security code-hopping
No. of Users	40 transmitters max
Memory	EEPROM, access via GT/SYSTEM
Compatible transmitters	All Merlin 433 MHz keyring or wall mounted transmitters, wireless wall-switches, wireless keypad

NOTE Any additions or alterations outside of these specifications may void the product's warranty.

Service Centres

If an Authorised Installer installed your unit then call them for prompt on-site service. See your yellow pages or phone Merlin toll free.

New Zealand

Auckland phone 09 415 4393

Phone toll free 0800 653 667 or 0800 MERLIN

Fax toll free 0800 653 663

Australia

NSW, Vic, Qld, WA

Phone toll free 1 800 638 234

Fax: toll free 1 800 640 243

United Kingdom

Phone toll free in the UK 0800 073 0112

Tel: +44 1709 514 533

Fax: +44 1709 514 534

www.merlingo.com



Quick setup guide

WARNING Read the manual! Follow all installation and safety instructions in the manual.

Learn remote controls

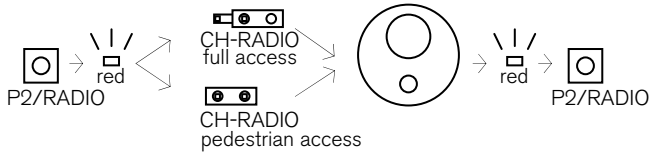

Adjust trimmers and set jumpers

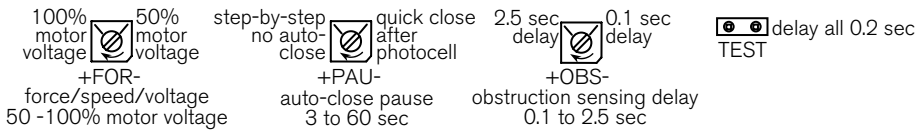

Easy setup

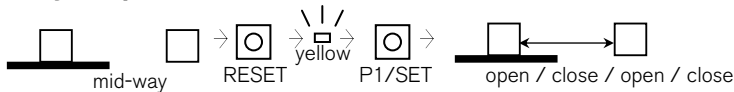

Professional setup

